

DESO

ENGINEERING

Deso Engineering
Slade Way
Roughmoor Industrial Estate
Williton
Somerset
TA4 4TB

Telephone - 01984 632026
Fax - 01984 634267
enquiries@desoengineering.co.uk

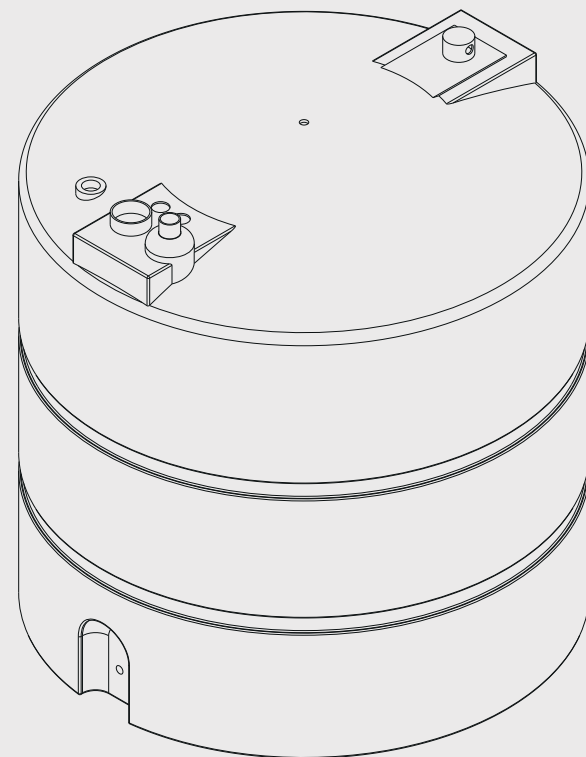

V2455

Weight	60kg
Capacity	2455litres
Diameter	1510mm
Length	-
Width	-
Height	1500mm
Ofcert licence No.	0668030705

V2455

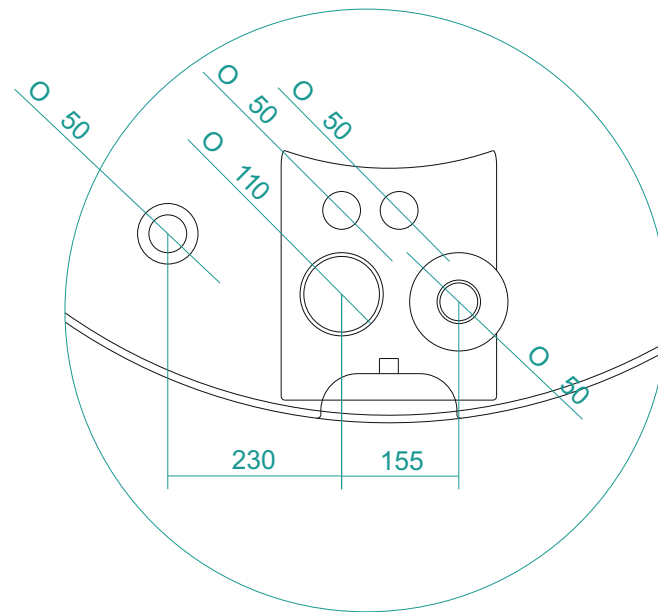
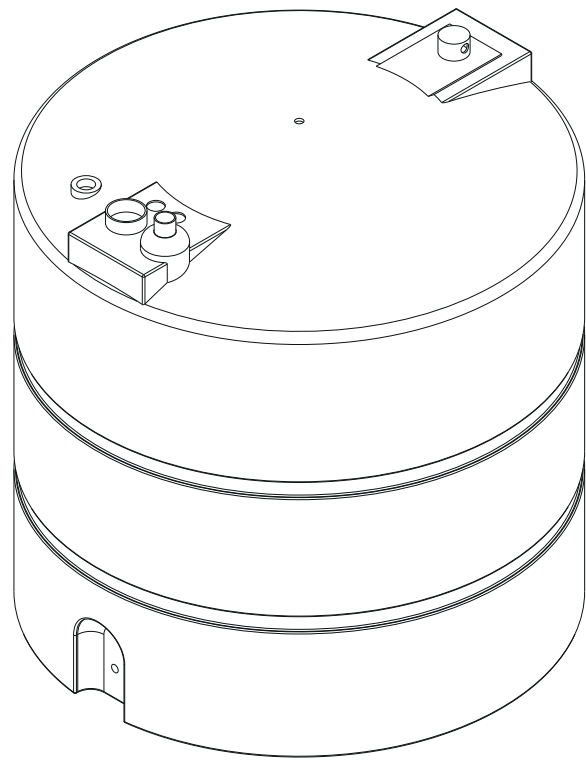
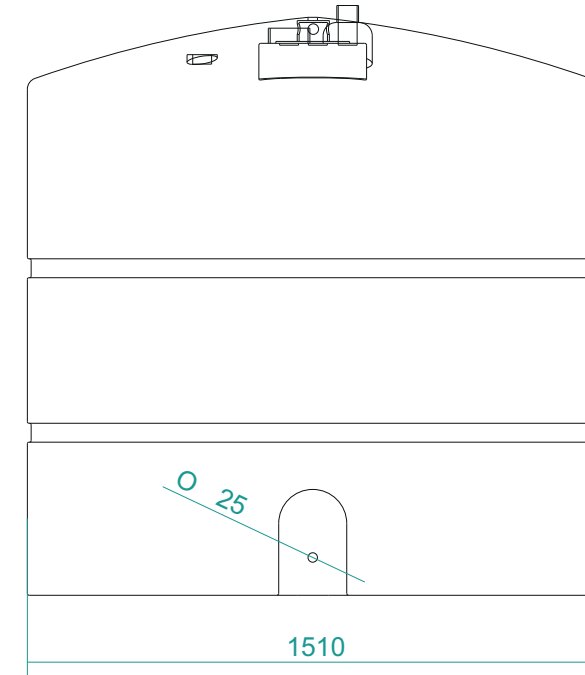
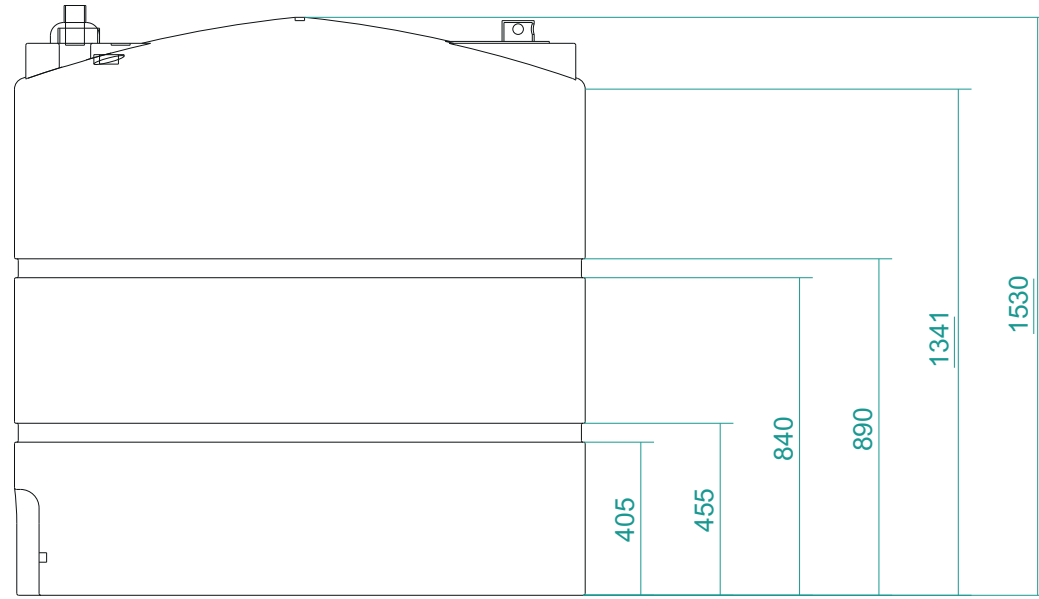

DETAIL A

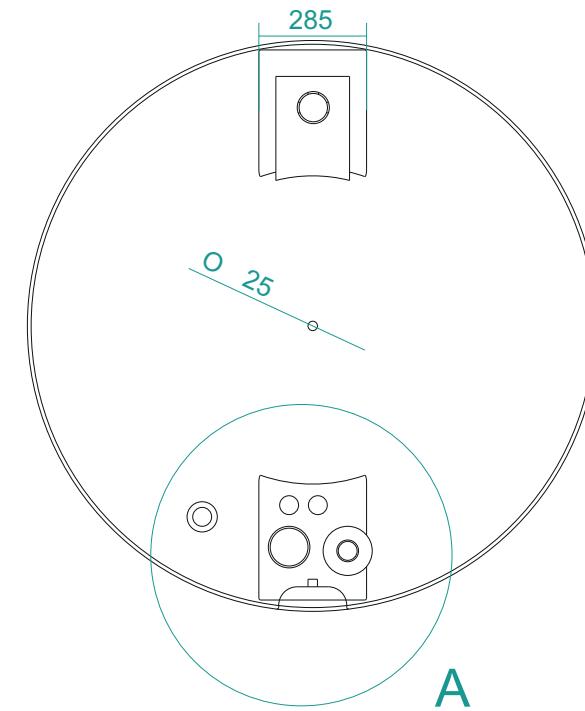

A

V2455	No. 1 of 1	3rd Angle Orthographic	scale: 1:20	Design by Inky Design www.inky-design.co.uk
DESO ENGINEERING Telephone - 01984 632026		drawn by: Jonathan Taphouse (BEng)		
		date: 15 - 04 - 2008	ISO	