



Tank Specification

Length: 1750 mm
Width: 670 mm
Height: 1250 mm

Product Mass: 72 kg

Capacity Brimful: 1174 litres
Capacity Nominal: 111 litres

Material Tank: MDPE

Approval Number: 0654120501R (OFTEC)

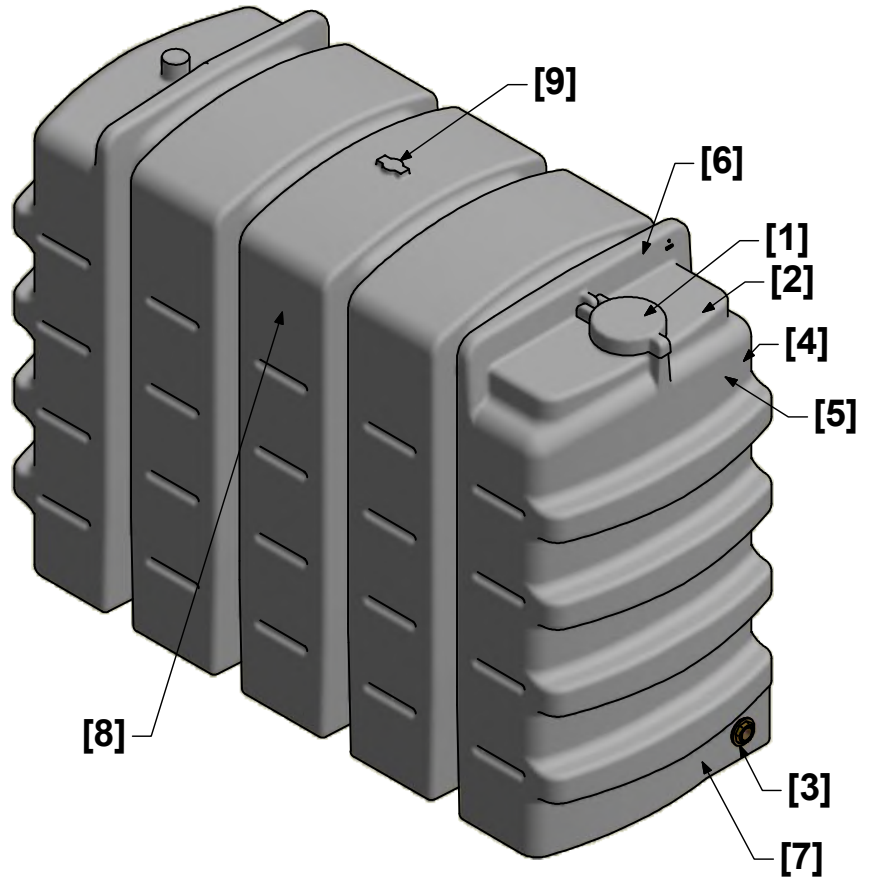

Equipment

1. 5" (~125mm) Inspection Lid - Lockable
2. Tank Serial Number Stamp
3. 1" (~25mm) Bottom Outlet
4. CE Label
5. Installation Instructions
6. Handle With Care Label
7. Left Hand Thread Label
8. Product Label
9. Ultrasonic Contents Gauge Location

STGR00650R-OFT [OFTEC UK]

10. 2" BSP (~50mm) Vent
11. 2" BSP (~50mm) Offset Fill Connection - Lockable

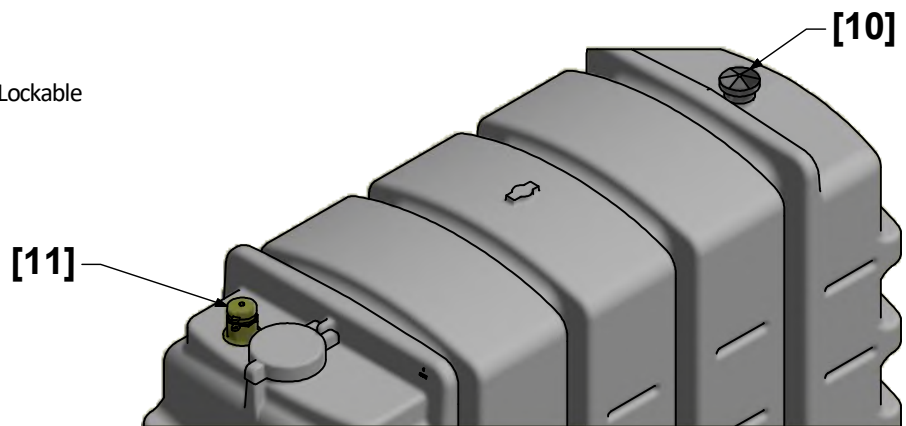

Installation & Siting Guidelines

Carbery Tanks must only be installed and commissioned by a suitably competent person in accordance with supplied instructions and all prevailing statutory requirements.

Please Consult the Installation, Operation and Maintenance Manual for further Information.

Certification

All Carbery Plastics LTD tanks are certified to EN13341.